

Radio frequenza



Cronotermostato (99 x 90 x 23 mm) bianco a radio frequenza con marcia forzata programmabile. Trasmissione senza fili attraverso onde radio. Il termostato programmabile radio è concepito per regolare la temperatura ambiente controllando, attraverso l'utilizzo di un ricevitore, l'emettitore di calore. Il termostato ambiente permette anche la programmazione giornaliera e settimanale di due marce forzate. Ogni termostato può controllare più ricevitori (fi no a 4) ma ogni ricevitore può essere controllato da un solo termostato. Funzioni principali: regolazione della temperatura ambiente (da +5°C a +30°C), selezione delle modalità di funzionamento (Auto-comfort, Eco, Anti-gelo, Prog, stand-by) riscaldamento rapido della stanza grazie alla funzione marcia forzata (istantanea, programmabile e differita), blocco tastiera, impostazioni di sicurezza.

T10 -



Ricevitore (48 x 51 x 28 mm) radio frequenza on/off (controllato da un termostato a radio frequenza) a installazione nascosta. Il ricevitore riceve gli ordini radio emessi dal termostato ambiente. Ricezione degli ordini e delle informazioni senza fili grazie alle onde radio. E' un ricevitore per radiatori o scaldasalviette.

R10 -

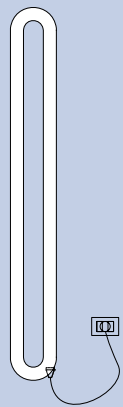

La distanza tra il ricevitore e il termostato a radio frequenza non deve essere maggiore di 10 metri.

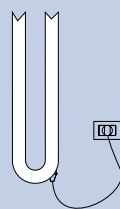
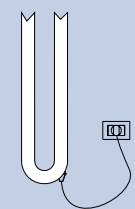
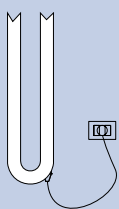
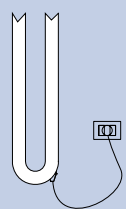

Con un solo termostato a radio frequenza è possibile controllare fino a 4 radiatori.

La distanza tra il ricevitore e il termostato a radio frequenza non deve essere maggiore di 10 metri.

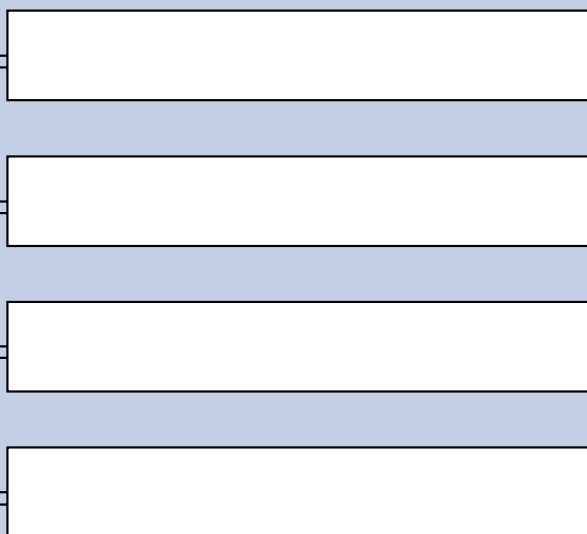

E' possibile gestire, con un solo ricevitore a radio frequenza, più radiatori per una potenza massima di 2000 Watt.

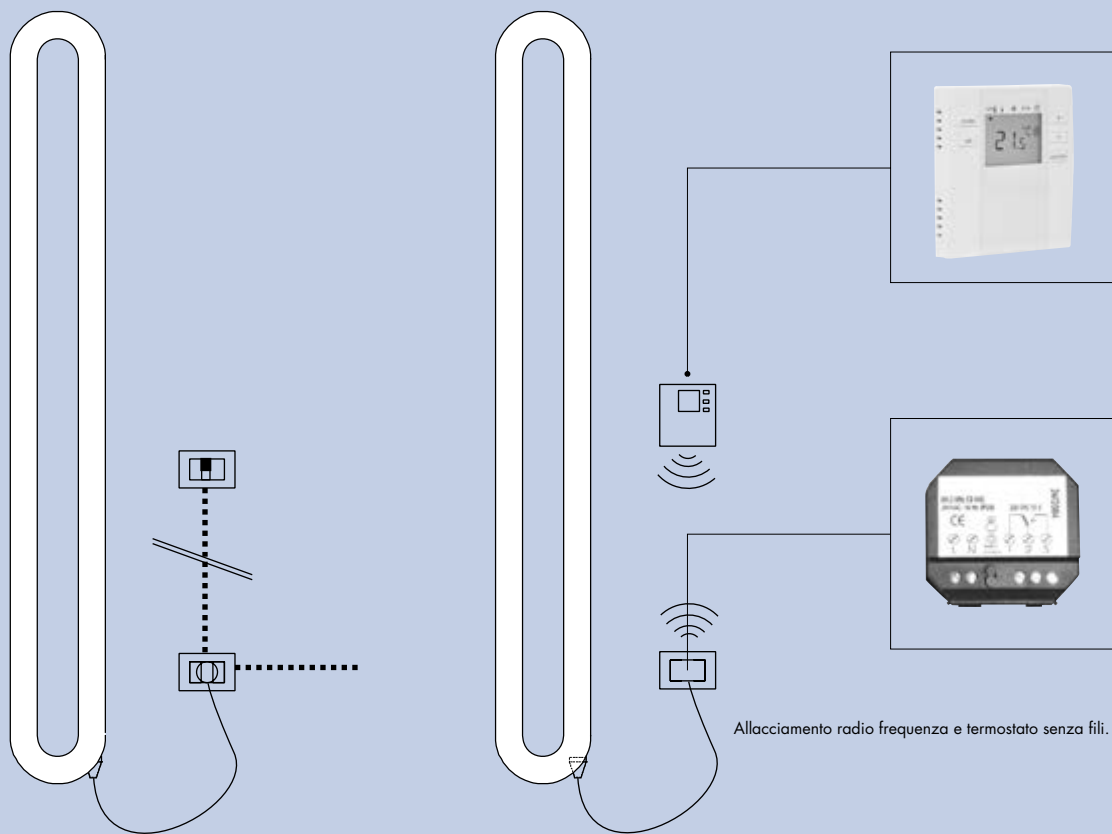

Allacciamento radio frequenza e termostato senza fili.

Allacciamento alla presa di corrente che è controllato da un interruttore on/off (non fornito da Antrax).

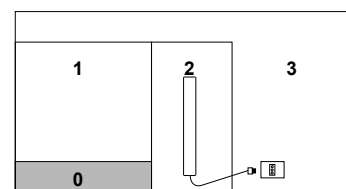
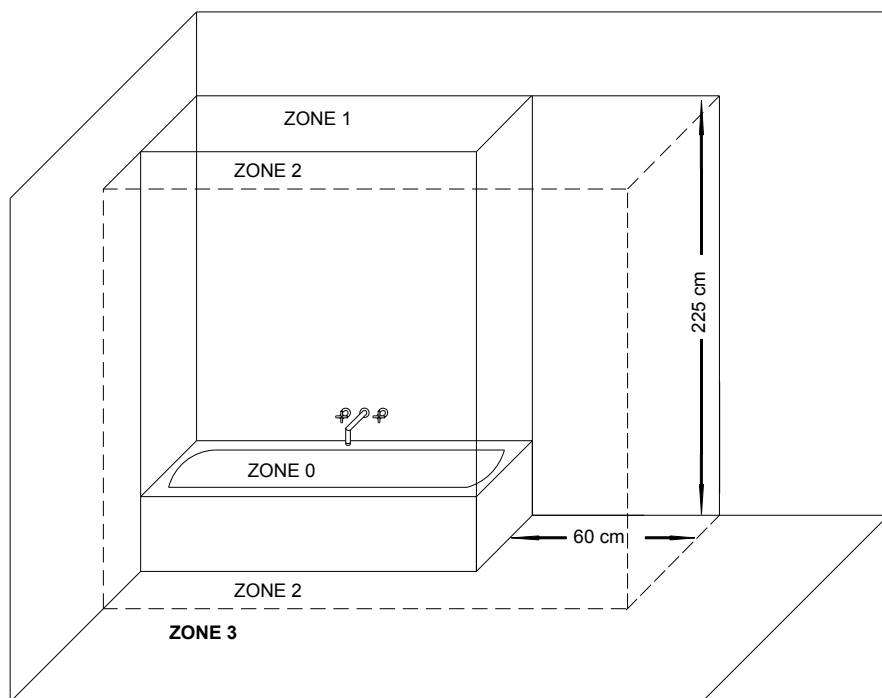

OK

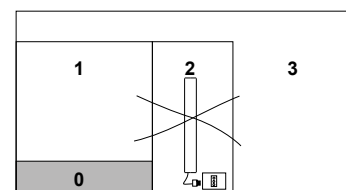

NO

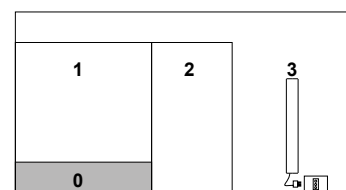

OK

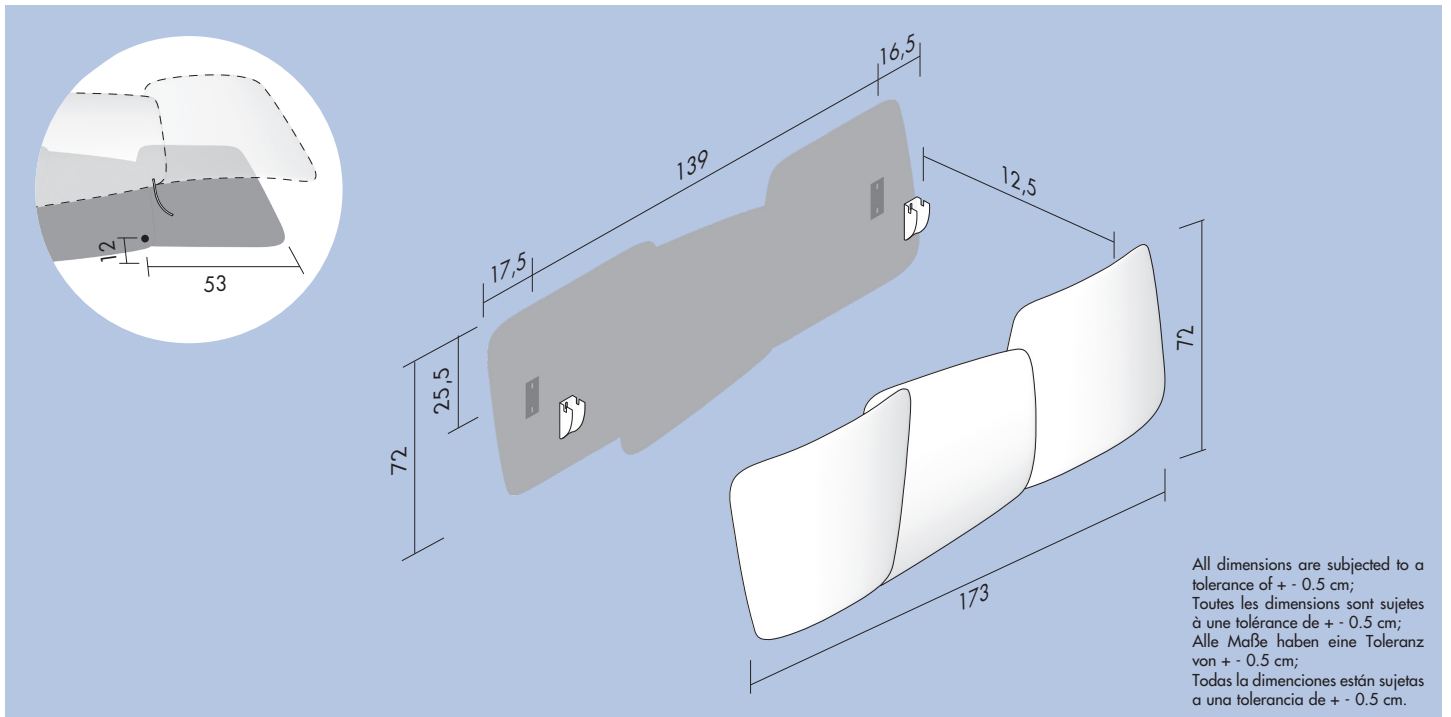

Electric with cable / Version électrique avec cable / Elektrische Ausführung mit Kabel / Versión electrica con cable

H cm	L cm	art*	watt
72.0	173.0	EC SCO173003	1 080

Optional



Receiver
Récepteur
Empfänger
Receptor

R10



Digital chronothermostat
Chronothermostat digital
Der digital Chronothermostat
Cronotermostato digital

T11

art* = item / modèle / Artikel / artículo